



Made in America

# Combo Wrist Strap / Footwear Tester

## Installation, Operation and Maintenance

### Pass Range 750K - 10M and 750K - 100M



Figure 1. Desco 19250 Combo Tester

### Description

The Desco [19250](#) Combo Tester is a 3-state touch tester designed for fast, frequent testing of ESD personnel grounding devices. This product can be used as one of the tools to fulfill the ANSI ESD S20.20 paragraph 6.1.3.2 "Compliance Verification Plan. Verification should include routine checks of the Technical Requirements of the Plan." The Combo Tester incorporates a unique dual test circuit design which improves accuracy of testing and eliminates the need for separate wrist strap and foot grounder test units. The [19250](#) is equipped with a 750 kilohm - 10 megohm circuit, ideal for testing of wrist straps and a 750 kilohm - 100 megohm circuit designed for accurate testing of footwear.

Test parameters are factory set but can be adjusted to match your own specifications. The [19250](#) is very simple to operate. A green light signals the user that everything is OK. A red light and an audible indicator means that the circuit resistance is either too low or too high.

The Tester operates on either a 9 volt battery or a special AC adapter. The Combo Tester is calibrated to NIST traceable standards and is available in three models.

Model	Description
<a href="#">19250</a>	Combo Tester, 9 Volt battery
<a href="#">19253</a>	Combo Tester w/ Footplate
<a href="#">19252</a>	Combo Tester w/ Stand
<a href="#">98273</a>	Foot Plate for Combo Tester
<a href="#">98254</a>	Stand for Combo Tester
<a href="#">98256</a>	AC Adapter, 120V
<a href="#">98257</a>	AC Adapter, 220V

CAUTION: Use only the AC adapter designed for this unit: Item 98256 (120 volt) or Item [98257](#) (220 volt). Using any other adapters may damage the unit and void the warranty.

Per ESD Handbook ESD TR20.20 paragraph 5.3.2.4.4 Test Frequency "Typical test programs recommend that wrist straps that are used daily should be tested daily. However, if the products that are being produced are of such value that knowledge of a continuous, reliable ground is needed, and then continuous monitoring should be considered or even required."

Per ESD SP9.2 APPENDIX B - Foot Grounder Usage Guidance "Compliance verification should be performed prior to each use (daily, shift change, etc.). The accumulation of insulative materials on the FCS may increase the foot grounder system resistance. If foot grounders are worn outside the ESD protected area testing for functionality before reentry to the ESD protected area should be considered."

Per ESD SP9.2 APPENDIX C -Parallel Ground Paths

"A parallel ground path allows a flow of electrical current through a path that is not intended for the test. Parallel ground paths may be caused by several different situations.

For example:

- The path represented by the person standing with one shoe on the floor and the other shoe on the test apparatus. A parallel path may be created by the shoe on the floor. Current from the test instrument is then directed down two paths when it was intended to be directed down one. The correct path for the test is with one shoe in the air or on an insulating surface and the other shoe on the test plate.
- The path presented by a person inadvertently supporting themselves by means of one hand on another object such as a wall, table or supporting member in order to measure the resistance in one foot contact. The hand has created a parallel path to ground.
- The path represented by a person leaning against another object with other parts of the body in order to provide physical support during a testing sequence. This can then lead to other grounding paths and erroneous results."

### Packaging

Remove the Tester from the carton and inspect for damage.

Items included with model [19250](#):

- 1 Combo Tester
- 1 9 volt battery

Items included only with model [19253](#):

- 1 Combo Tester
- 1 Foot plate
- 1 Ground cord
- 1 9 volt battery

Items included only with model [19252](#):

- 1 Combo Tester
- 1 Base plate
- 1 Pedestal tube with bracket and boot installed
- 1 4" banana plug connector
- 1 Vinyl insulator cap
- 1 Wall poster
- 1 5/32" hex wrench
- 1 9 volt battery

Model numbers [19253](#) and [19252](#) are ideally suited for testing foot grounding devices.

## Installation

The Combo Tester may be used as a portable unit, or may be permanently mounted on either a table or a wall. Please refer to the following instructions when installing your tester.

### Stationary Installation

If you will be using the tester as a portable unit, you may prefer to mount the unit to a table or wall. Three keyhole slots on the back of the unit are included to allow you to attach the tester to a stationary surface.

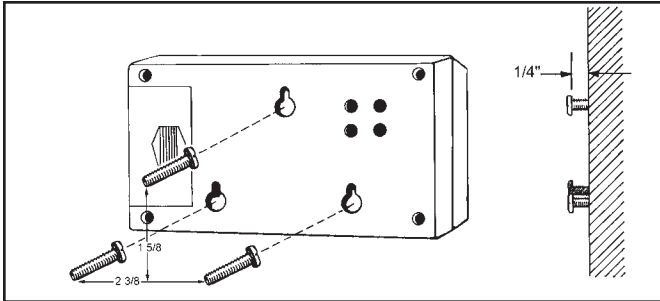

Figure 2. Mounting hole locations

- I. Select location for mounting Tester. Install three #6 or #8 screws spaced as illustrated in figure 3, into a wall or other vertical surface. Make sure that the screw heads do not project out more than 1/4" from mounting surface. The template on page four is actual size.
- II. Mount the Tester on the screws, pulling down to lock it in place.

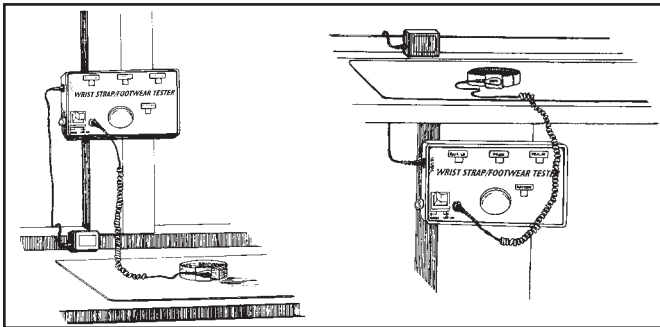

Figure 3. Stationary installation of the Combo Tester

## Operation

The Combo Tester can be operated either on battery or AC power. The unit comes equipped with a 9 volt alkaline battery. For AC operation, plug the optional AC adapter into the mini phone jack located on the upper left hand corner of the tester. AC adapters are sold separately as item [98256](#) (120 volt) or [98257](#) (220 volt).

### LOW BATTERY INDICATOR

The Combo Tester includes a low battery indicator alarm circuit. If both the audible alarm and indicator LED turn on during use, discontinue testing and replace the battery. The tester will continue to operate with a weak battery, but results should not be considered accurate.

The battery can be easily replaced by removing the battery compartment cover on the back of the unit and installing a new 9 volt battery.

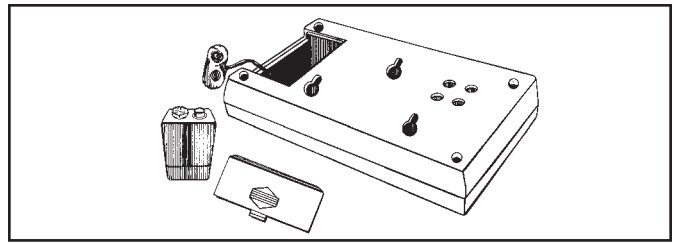

Figure 4. Replacing the battery

## General Instructions

In the following test configurations, the [19250](#) can be used to test wrist straps while they are worn. Models [19253](#) and [19252](#) will also allow the user to test footwear. Insertion of the banana plug on the wrist strap cord activates the wrist strap tester circuit and deactivates the footwear test circuit. NOTE: When testing or calibrating, press and hold for test results, then allow 1-2 seconds for the unit to reset before pressing the test button again.

### WRIST STRAP TESTING WITH MODEL [19250](#)

This test safely checks that a continuous path between the operator, wrist strap and ground cord exists.

- I. While wearing the wrist strap, plug the banana plug end of the cord into the jack on the face of the unit.
- II. Press rocker switch toward "WRIST CORD".
- III. Press the test button so that the unit activates. Hold down for 2-3 seconds.

NOTE: DO NOT TOUCH ANY OTHER METAL WHILE PERFORMING TEST.

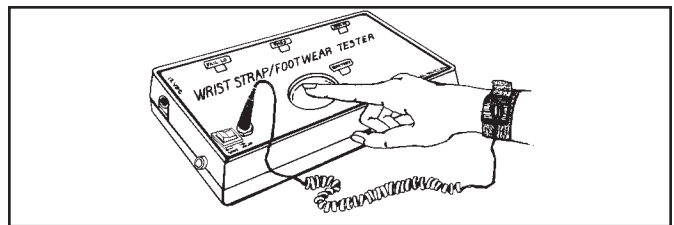

Figure 5. Testing the wrist strap

- IV. Lighting of the green "PASS" LED indicates that the wrist strap and ground cord assemblies are functioning properly.
- V. If either "FAIL LO" or "FAIL HI" LEDs light and the audible indicator sounds, the wrist strap wearer should check the wrist strap assembly immediately.

### TESTING FOOT GROUNDING DEVICES

In order to test footwear you will need the model [19253](#) or [19252](#) Combo Tester. The following instructions are intended for use while wearing foot grounding devices. When using a Footwear Tester that does not use a split footplate, one needs to test one foot at a time; best practice is to raise the other foot off the floor. When testing conductive shoes, or foot grounders worn on both feet, test each foot separately to test the separate path-to-ground. If the floor is an ESD floor, placing the other foot on the floor may result in erroneous test results. Care should also be taken not to create (hand resting on wall or bench) other paths-to-ground.

- I. Place the Foot Plate on the floor in front of the Combo Tester.
- II. Plug the plate's ground cord into the jack on the left hand side of the unit.

NOTE: Steps I and II are not required with the [19252](#).

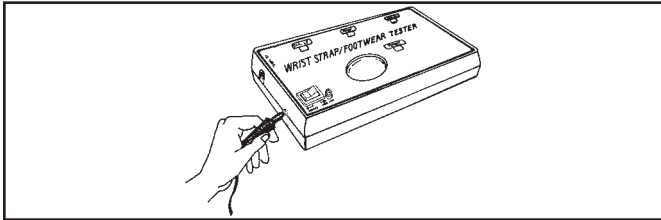

Figure 6. Installing ground cord to "FOOTPLATE" jack

- III. Press the rocker switch toward "FOOTPLATE."
- IV. Place one foot on the plate. If the floor is conductive, lift the foot you are not testing off of the floor during this test. Make sure there is no cord plugged into the "WRIST CORD" jack.
- V. Press the test button so that the unit activates. Hold for 2-3 seconds.

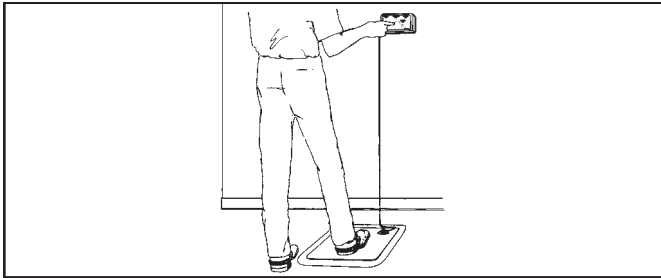

Figure 7. Testing foot grounding devices with [19253](#).

- VI. Lighting of the green "PASS" LED indicates that the foot ground assemblies are functioning properly.
- V. If either red "FAIL LO" or red "FAIL HI" LEDs light and the audible indicator sounds, the wearer should check the foot grounding device immediately.
- VI. Repeat steps III through VI with other foot.

## Free Standing Test Fixture Assembly and Operation (Model [19252](#))

The [19252](#)'s rugged steel pedestal tube is powder coated in a non-conductive white finish that helps to prevent false readings if contacted by skin or loose smocks.

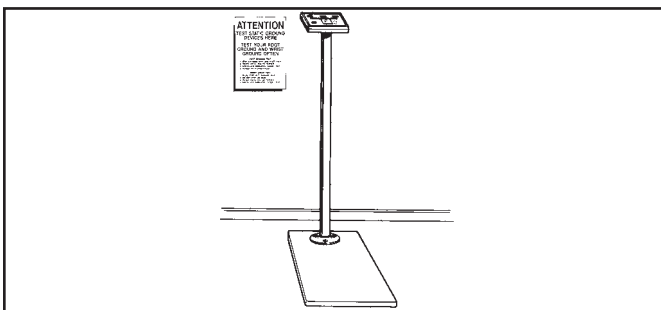

Figure 8. The [19252](#) Free Standing Test Fixture

## Assembly

- I. Remove 3 screws from baseplate.
- II. Position pedestal on the baseplate with the Tester mounting bracket pointing away from the operator. Attach pedestal to baseplate using the three screws provided. Tighten with hex wrench provided.

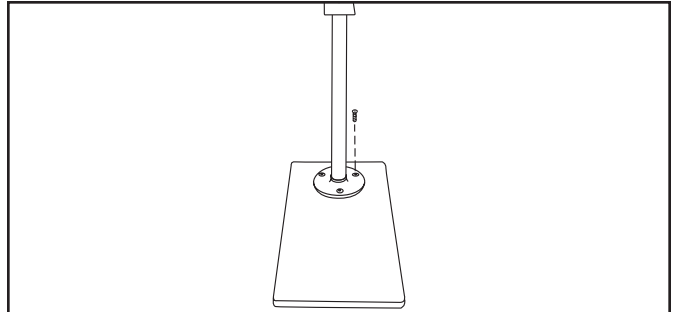

Figure 9. Attaching pedestal to baseplate

- III. Open the compartment and attach the snap connector to the included 9 volt battery. Attach poster to the wall at eye level in front of the Tester location.
- IV. Install the Tester on the bracket by aligning keyholes on the back of tester with mounting studs on bracket. While pushing up on thumb screw, insert the mounting studs into the keyholes and slide the tester down. See Figure 10.

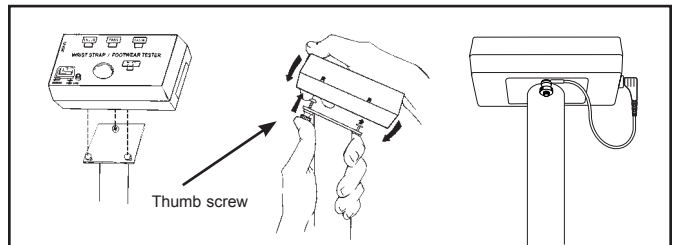

Figure 10. Installing Tester on bracket and securing Tester to bracket

- V. Install the 4" banana plug connector to "FOOTPLATE" jack on the side of the unit. Insert ring terminal behind thumb screw.
- VI. Twist the thumb screw clockwise to secure the tester to the bracket. Cover thumb screw with vinyl insulator cap.

## WRIST STRAP TESTING

This test verifies that a continuous path between the operator, wrist strap, and ground cord exists.

- I. While wearing the wrist strap, plug the banana plug end of the cord into the jack on the face of the unit.
- II. Press rocker switch toward "WRIST CORD".
- III. Press the test button so that the unit activates. Hold down for 2-3 seconds.

NOTE: DO NOT TOUCH ANY OTHER METAL WHILE PERFORMING TEST.

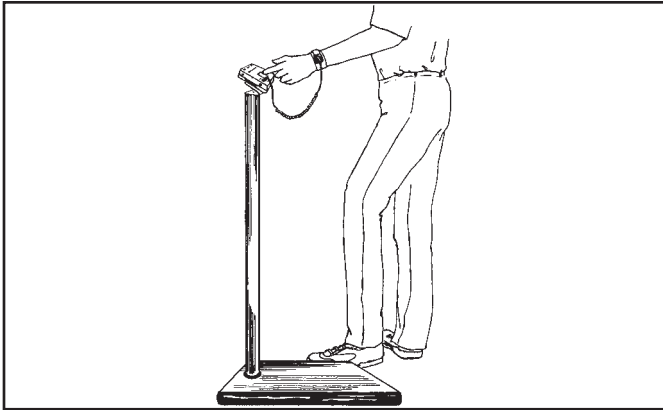

Figure 11. Testing of wrist strap grounding assemblies

- IV. Lighting of the green "PASS" LED indicates that the wrist strap and ground cord assemblies are functioning properly.
- V. If either red "FAIL LO" or "FAIL HI" LEDs light and the audible indicator sounds, the wrist strap wearer should check the wrist strap assembly immediately.

**TESTING FOOT GROUNDING DEVICES**

When using a Footwear Tester that does not use a split footplate, one needs to test one foot at a time; best practice is to raise the other foot off the floor. When testing conductive shoes, or foot grounders worn on both feet, test each foot separately to test the separate path-to-ground. If the floor is an ESD floor, placing the other foot on the floor may result in erroneous test results. Care should also be taken not to create (hand resting on wall or bench) other paths-to-ground.

- I. Press rocker switch toward "FOOTPLATE".
- II. Place one foot on the plate. If the floor is conductive, lift the foot you are not testing off of the floor during this test. Make sure there is no cord plugged into the "WRIST CORD" jack.
- III. Press the test button so that the unit activates. Hold down for 2-3 seconds.

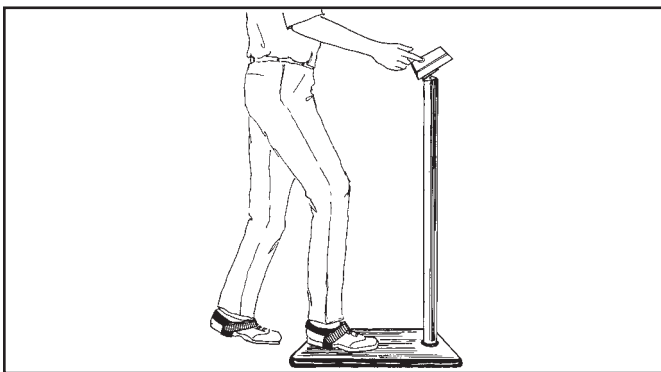

Figure 12. Testing foot grounding devices

- IV. Lighting of the green "PASS" LED indicates that the foot ground assemblies are functioning properly.
- V. If either red "FAIL LO" or red "FAIL HI" LEDs light and the audible indicator sounds, the wearer should check the foot grounding device immediately.
- VI. Repeat steps I - III with other foot.

**Calibration**

The models [19250](#), [19253](#), and [19252](#) are calibrated to NIST traceable standards. We recommend that calibration is performed annually to ensure that the Tester is operating within limits. Due to its dual circuit design both test circuits of the Combo Tester must be calibrated individually.

Desco offers a calibration unit that is specifically designed to simplify the calibration procedure. This unit is sold as item [07010](#). The Calibration Unit comes calibrated to NIST traceable standards. For additional information on the [07010](#), ask for Technical Bulletin [TB-2039](#).

**750 Kilohm - 10 Megohm TEST RANGE - WRIST STRAPS**

The following resistance should give the display shown:

Resistance Value (± 1%)	Test Output
675 Kilohm	Red (Fail Lo)
825 Kilohm	Green (Pass)
8.5 Megohm	Green (Pass)
11.5 Megohm	Red (Fail Hi)

**750 Kilohm - 100 Megohm TEST RANGE - FOOTWEAR**

The following resistance should give the display shown:

Resistance Value (± 1%)	Test Output
675 Kilohm	Red (Fail Lo)
825 Kilohm	Green (Pass)
80 Megohm	Green (Pass)
120 Megohm	Red (Fail Hi)

To calibrate, simply test each resistance value shown above which are included in the [07010](#) Calibration Unit. Test across the test button and "WRIST CORD" jack for calibration of the 750 Kilohm - 10 Megohm range. Test across the test button and "FOOTPLATE" jack for calibration of the 750K - 100M range. Be sure rocker switch is set correctly.

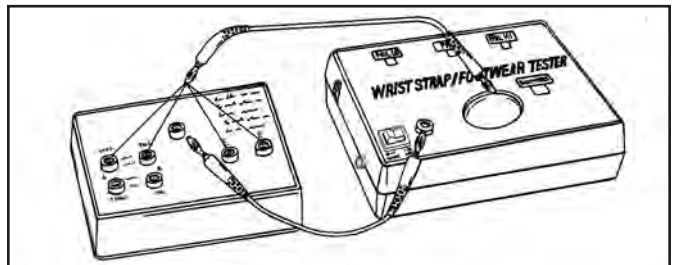

Figure 13. Calibration of the Combo Tester's 750 kilohm to 100 megohm range

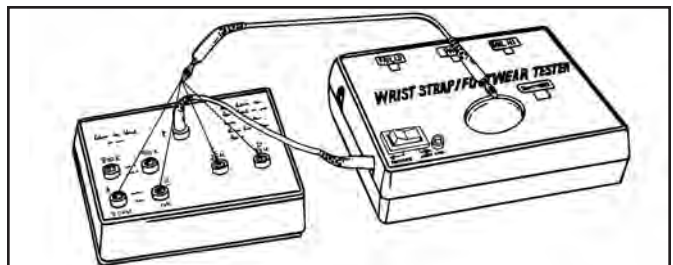

Figure 14. Calibration of the Combo Tester's 750 kilohm to 10 megohm range

Observe the LEDs for the proper response as indicated. Be sure to hold the cord at an insulated point, so that resistance value is not affected by the body. Should testing reveal that the Tester is not functioning properly, verify that the battery or power supply is operating correctly.

Tester calibration can also be verified with the use of discrete resistors and two banana-to-alligator cords.

## Adjustment

Detailed adjustment instructions follow:

Equipment Required: - Small blade screwdriver or Trimpot adjusting tool, manufacturer's calibration box or a resistor decade box or discrete resistors, with appropriate test leads.

### PREPARATION OF THE UNIT:

- I. Make sure that a fresh 9 Volt alkaline battery is installed.
- II. Orient tester so that it corresponds to Figure 15.

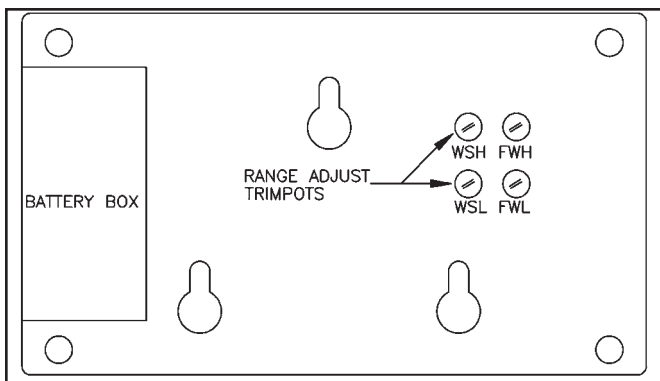

Figure 15. Back of the Combo Tester

### CALIBRATION OF WRIST STRAP RANGES:

- III. Connect resistance "A" from Table 1 OR 2 between the touch plate and the "WRIST CORD" banana jack. **A banana plug must be inserted in the banana jack to properly test the wrist strap ranges.** Press and hold the touch plate. The red "FAIL LO" LED should illuminate.
- IV. If required, adjust **WSL** trimpot to the point where the "FAIL LO" LED illuminates.
- V. Connect resistance "B" and press the switch as in Step III. The green "PASS" LED should illuminate. The **WSL** trimpot may require a slight re-adjustment.
- VI. Connect resistance "C" (**wrist strap range**) and press the switch as in Step III. The green "PASS" LED should be on. If required, adjust the **WSH** trimpot to the point where the green "PASS" LED illuminates.
- VII. Finally, connect resistance "D" (**wrist strap range**) and press the switch as in Step III. The "FAIL HI" red LED should be on. The **WSH** trimpot may require re-adjustment.
- VIII. Re-check to insure that all ranges are correct, then proceed to calibrate footwear ranges.

TABLE 1 - STANDARD RANGES

RANGE	FAIL LO	PASS LO	PASS HI	FAIL HI
WRIST STRAP	675K	825K	8.5M	11.5M
FOOT WEAR	675K	825K	80M	120M
RESISTANCE	"A"	"B"	"C"	"D"

### CALIBRATION OF FOOT WEAR RANGES:

- I. Connect resistance "A" from table 1 or 2, this time between the touch plate and the "FOOTPLATE" banana jack on the left side of the tester. For footwear calibration, press and hold the touch plate. The red "FAIL LO" LED should be on.
- II. If required, adjust **FWL** trimpot to the point where the "FAIL LO" LED illuminates.
- III. Connect resistance "B" and press switch as in Step I. The green "PASS" LED illuminates. The **FWL** trimpot may require a slight re-adjustment.
- IV. Connect resistance "C" (**footwear range**) and press switch as in Step I. The green "PASS" LED should illuminate. If required, adjust the **FWH** trimpot to the point where the green LED illuminates.
- V. Finally, connect resistance "D" (**footwear range**) and press switch as in step I. The red "FAIL HI" LED should illuminate. The **FWH** trimpot may require a slight re-adjustment.
- VI. Re-check to insure that all footwear ranges are correct.

### RETURN UNIT TO SERVICE.

Unauthorized modifications will void the product warranty. Servicing should be performed only at the factory. See warranty section for repair information.

## Specifications

### Wrist Strap Circuit

FAIL HI Factory set at 11.5 Megohms  
 FAIL LO Factory set at 675 Kilohms

### Footwear Circuit

FAIL HI Factory set at 120 Megohms  
 FAIL LO Factory set at 675 Kilohms

### General Characteristics

Power 9 Volt battery or optional AC power supply  
 Operation Resistance bridge  
 Readout Three LED's & audible alarm  
 Accuracy ±20%  
 Weight 12 pounds  
 Height 39 inches

Consider adding the [19250](#) to your list of "test equipment [that] shall be selected to make measurements of appropriate properties of the technical requirements that are incorporated into the ESD program plan" as required by paragraph 6.1.3.1 of ANSI/ESD S20.20.

+

**DRILL PATTERN  
FOR  
COMBO TESTER  
ACTUAL SIZE**

+

**Limited Warranty**

Desco expressly warrants that for a period of one (1) year from the date of purchase, Desco Combo Testers will be free of defects in material (parts) and workmanship (labor). Within the warranty period, the product will be tested, repaired, or replaced at Desco's option, free of charge. Call our Customer Service Department at 909-627-8178 (Chino, CA) or 781- 821-8370 (Canton, MA) for a Return Material Authorization (RMA) and proper shipping instructions and address. Include a copy of your original packing slip, invoice, or other proof of purchase date. Any unit under warranty should be shipped prepaid to the Desco factory. Warranty repairs will take approximately two weeks.

If your unit is out of warranty, call Customer Service at 909-627-8178 (Chino, CA) or 781-821-8370 (Canton, MA) for a Return Material Authorization (RMA) and proper shipping instructions and address. Desco will quote repair charges necessary to bring your unit up to factory standards.

**Warranty Exclusions**

THE FOREGOING EXPRESS WARRANTY IS MADE IN LIEU OF ALL OTHER PRODUCT WARRANTIES, EXPRESSED AND IMPLIED, INCLUDING MERCHANTABILITY AND FITNESS FOR A PARTICULAR PURPOSE WHICH ARE SPECIFICALLY DISCLAIMED. The express warranty will not apply to defects or damage due to accidents, neglect, misuse, alterations, operator error, or failure to properly maintain, clean or repair products.

**Limit of Liability**

In no event will Desco or any seller be responsible or liable for any injury, loss or damage, direct or consequential, arising out of the use of or the inability to use the product. Before using, users shall determine the suitability of the product for their intended use, and users assume all risk and liability whatsoever in connection therewith.